



ART STEEL
catering equipment

Refrigerators Freezers Counters

2

Line 60

Line 70

Salad Line

Low counters

Line 80

Pizza Counter

Bottle cooler height 90-100

Specifications

- Stainless steel interior & exterior construction
- Polyurethane Ecological insulation
- Health Cooler Pad
- Grids laminated, height adjustable
- Inox Guides for GN basins
- Hinged Doors with automatic reset system
- Limit switch for fan shutdown upon door opening
- Magnetic gaskets [removable]
- Ecological Refrigerant R449a or R290
- Electronic thermostat - thermometer for temperature control
- Automatic defrosting
- Sewerage system including water evaporator
- Cooling Convection
- Static Cooling System

Τεχνικά Χαρακτηριστικά

- Κατασκευασμένα εσωτερικά & εξωτερικά από ανοξείδωτο χάλυβα
- Μόνωση με Οικολογική πολυουρεθάνη
- Υγειονομικός Πάτος ψυγείου
- Σχάρες πλαστικοποιημένες, ρυθμιζόμενες καθ' ύψος
- Οδηγοί inox για GN λεκανάκια
- Πόρτα με μεντεσέδες επαναφοράς
- Τερματικός διακόπτης για διακοπή λειτουργίας του ανεμιστήρα με το άνοιγμα της πόρτας
- Μαγνητικά λάστιχα [αφαιρούμενα]
- Ψυκτικό οικολογικό υγρό R449a ή R290
- Ηλεκτρονικός θερμοστάτης - θερμομέτρο για έλεγχο της θερμοκρασίας
- Αυτόματη απόψυξη
- Σύστημα αποχέτευσης με εξατμιστή νερού
- Σύστημα στατικής Ψύξης

Our company completing all investment needs in equipment, is able to present the most complete range of counter refrigerators with many new features and improvements which we will analyze below.

Many refrigerators are now manufactured with the new R290a refrigerant as an option, we now use a new thermostat far superior to previous ones.

The wide range of counter refrigerators we offer allows you to meet all the needs for maintenance, freezing of products and organization of your workplace in the best possible way.

1. Series of 60cm

It is available in many dimensions and with many options such as with drawers, with a sink, with a glass door etc. The 60 series, due to its size, can be applied in professional narrow spaces such as bars, restaurants, etc.

2. Series of 70cm

The basic dimensions of gastronorm refrigerators are available in dimensions from 94cm to 282cm with many options: with integrated machine or without machine or with the possibility of applying a sink on top of the machine, etc. Special holes can also be made for basins and glass doors can be installed.

3. Series of 80cm.

It is the classic 40x60 series for pastry shops and pizzerias. The three options like the 70 series also apply here.

4. A great innovation in the catalog is the construction of a refrigerator with a useful height of 80cm inside and a total height of 100cm outside. More details of which you can find into the catalog. These refrigerators are intended for large needs in liters of cooling for water, beer, etc.

5. In order to give more choices in space, we have manufactured two innovative new models of refrigerators in dimension 70cm with 1 door, 120cm with 2 doors, 160cm with 3 doors and 215cm with 4 doors, with a small machine space and a new innovative way of building a engine room.

6. A great innovation is also the construction of a low height refrigerator 65cm modulo 40cm where all kitchen appliances, fryer, grill and others can be fitted exactly. We produce in three dimensions 120cm, 160cm and 200cm. We also keep the previous low refrigerator dimensions for more options.

7. Also, we created a full range of salad bar refrigerators in many dimensions and with many choices of materials and decorations..



Η εταιρεία μας ολοκληρώνοντας όλες τις ανάγκες επένδυσης σε εξοπλισμό είναι σε θέση να παρουσιάσει την πιο πλήρη γκάμα ψυγείων πάγκων με πολλά νέα χαρακτηριστικά και βελτιώσεις τα οποία θα αναλύσουμε παρακάτω.

Όλα τα ψυγεία πλέον κατασκευάζονται με το νέο ψυκτικό υγρό R290a κατόπιν επιλογής, χρησιμοποιούμε πλέον ένα νέο θερμοστάτη κατά πολύ ανώτερο από προηγούμενους.

Η μεγάλη γκάμα των ψυγείων πάγκων που προσφέρουμε επιτρέπει την κάλυψη όλων των αναγκών για συντήρηση, κατάψυξη προϊόντων και οργάνωση του χώρου εργασίας σας με τον καλύτερο δυνατό τρόπο.

1. Σειρά 60cm

Διατίθεται σε πολλές διαστάσεις και με πολλές επιλογές όπως με συρταριές, με γούρνα και με κρυστάλλινη πόρτα. Η σειρά 60, λόγω του μεγέθους μπορεί να εφαρμοστεί σε επαγγελματικούς στενούς χώρους όπως μπαρ εστιατόρια κ.τ.λ.

2. Σειρά 70cm

Οι βασικές διαστάσεις ψυγείου gastronorm διατίθενται σε διαστάσεις από 94cm έως 282cm με πάρα πολλές επιλογές: με ενσωματωμένη μηχανή, χωρίς μηχανή, με την δυνατότητα εφαρμογής γούρνas πάνω από τη μηχανή κ.α. Επίσης μπορούν να γίνουν ειδικές οπές για λεκανάκια και να τοποθετηθούν κρυστάλλινες πόρτες.

3. Σειρά 80cm

Είναι η κλασική σειρά 40x60 για ζαχαροπλαστεία και πισαρίες. Επίσης ισχύουν και εδώ οι τρεις επιλογές όπως στην σειρά 70.

4. Μεγάλη καινοτομία στον κατάλογο είναι κατασκευή ψυγείου με ωφέλιμο ύψος 80cm εσωτερικά και συνολικού ύψους 100cm εξωτερικά. Περισσότερες λεπτομέρειες των οποίων θα βρείτε τον κατάλογο. Τα ψυγεία αυτά προορίζονται για μεγάλες ανάγκες σε λίτρα ψύξης για νερά, μπύρες κ.τ.λ.

5. Θέλοντας να δώσουμε περισσότερες επιλογές σε χώρο κατασκευάσαμε δύο καινοτόμα νέα μοντέλα ψυγείων σε διάσταση 70cm με 1 πόρτα, 120cm με 2 πόρτες, 160cm με 3 πόρτες και 215cm με 4 πόρτες με μικρό χώρο μηχανής και ένα νέο πρωτοποριακό τρόπο κατασκευής μηχανοστασίου.

6. Μεγάλη καινοτομία επίσης είναι η κατασκευή ψυγείου χαμηλού ύψους 65cm modulo 40cm όπου μπορούν να χωρέσουν ακριβώς όλες οι συσκευές κουζίνας, φριτέζα, γκριλ και άλλα. Παράγουμε σε τρεις διαστάσεις 120cm, 160cm και 200cm. Επίσης διατηρήσαμε τις μέχρι τώρα διαστάσεις χαμηλού ψυγείου για περισσότερες επιλογές.

7. Τέλος δημιουργήσαμε μια πλήρη γκάμα ψυγείων salad bar σε πολλές διαστάσεις και με πάρα πολλές επιλογές υλικών και επενδύσεων



Refrigerated Counters

ΨΥΓΕΙΑ ΠΑΓΚΟΙ



Counters Specifications

WIDTH: 60cm

Models R290	Dimensions (l) x (w) x (h) cm	
T0-286-4	280 x 60 x 5	
T0-296-4	290 x 60 x 5	
T0-306-4	300 x 60 x 5	
T0-316-4	310 x 60 x 5	
T0-326-4	320 x 60 x 5	
T0-336-4	330 x 60 x 5	
T0-346-4	340 x 60 x 5	
T0-356-4	350 x 60 x 5	
T0-366-4	360 x 60 x 5	
T0-376-4	370 x 60 x 5	
T0-386-4	380 x 60 x 5	

WIDTH: 70cm

Models R290	Dimensions (l) x (w) x (h) cm	
T0-287-4	280 x 70 x 5	
T0-297-4	290 x 70 x 5	
T0-307-4	300 x 70 x 5	
T0-317-4	310 x 70 x 5	
T0-327-4	320 x 70 x 5	
T0-337-4	330 x 70 x 5	
T0-347-4	340 x 70 x 5	
T0-357-4	350 x 70 x 5	
T0-367-4	360 x 70 x 5	
T0-377-4	370 x 70 x 5	
T0-387-4	380 x 70 x 5	

WIDTH: 80cm

Models R290	Dimensions (l) x (w) x (h) cm	
T0-288-4	280 x 80 x 5	
T0-298-4	290 x 80 x 5	
T0-308-4	300 x 80 x 5	
T0-318-4	310 x 80 x 5	
T0-328-4	320 x 80 x 5	
T0-338-4	330 x 80 x 5	
T0-348-4	340 x 80 x 5	
T0-358-4	350 x 80 x 5	
T0-368-4	360 x 80 x 5	
T0-378-4	370 x 80 x 5	
T0-388-4	380 x 80 x 5	

Line 60

BARLINE

Refrigerated Counters 60cm DEPTH



1 2

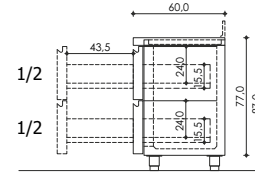
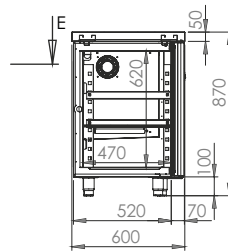

Double Drawers_ **€400**
Διπλή Συρταριέρα

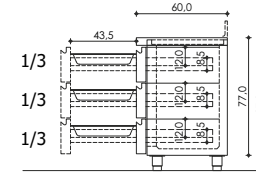

Triple Drawers_ **€600**
Τριπλή Συρταριέρα

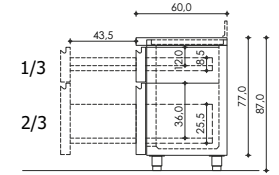

1/3-2/3 Drawers_ **€400**
1/3-2/3 Συρταριέρα

Soft close drawer runners_ **€50**
Συρταριέρες με μαλακό κλείσιμο



5 6

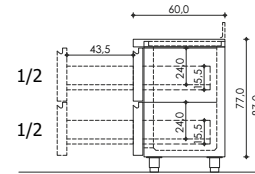
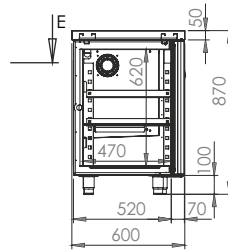

Double Drawers_ **€400**
Διπλή Συρταριέρα

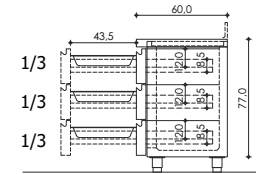

Triple Drawers_ **€600**
Τριπλή Συρταριέρα

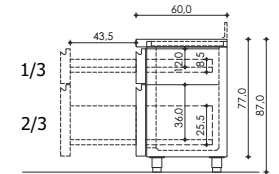

1/3-2/3 Drawers_ **€400**
1/3-2/3 Συρταριέρα

Soft close drawer runners_ **€50**
Συρταριέρες με μαλακό κλείσιμο

Line 60 Specifications



3

4

	Models R290	Models R449a	Dimensions (l) x (w) x (h) cm	Vol. (lt)	Doors No	Power (W)/(hp)	Temp. (°C)	Grid (l) x (w) cm
①	TS-096-DR	TS-096-D	94 x 60 x 87	160	1 Large 1 Small	435 / (1/4)	0 / +8	33.5 x 47
②	TS-106-DR	TS-106-D	107 x 60 x 87	190	1 Large 1 Small	435 / (1/4)	0 / +8	46 x 47
③	TS-146-DR	TS-146-D	141 x 60 x 87	240	2 Large 1 Small	590 / (3/8)	0 / +8	33.5 x 47
④	TS-186-DR	TS-186-D	188 x 60 x 87	400	3 Large 1 Small	772 / (1/2)	0 / +8	33.5 x 47



7 8

9 10

	Models R290	Models R449a	Dimensions (l) x (w) x (h) cm	Vol. (lt)	Power (W)/(hp)	Temp. (°C)	Grid (l) x (w) cm	
⑤	TR-146-2R	TR-146-2	141 x 60 x 87	220	435 / (1/4)	0 / +8	33.5 x 47	2 DOORS
⑥	TR-156-2R	TR-156-2	154 x 60 x 87	250	435 / (1/4)	0 / +8	40 x 47	
⑦	TR-186-3R	TR-186-3	188 x 60 x 87	310	590 / (3/8)	0 / +8	33.5 x 47	3 DOORS
⑧	TR-206-3R	TR-206-3	207 x 60 x 87	370	590 / (3/8)	0 / +8	40 x 47	
⑨	TR-236-4R	TR-236-4	235 x 60 x 87	420	772 / (1/2)	0 / +8	33.5 x 47	4 DOORS
⑩	TR-266-4R	TR-266-4	260 x 60 x 87	510	772 / (1/2)	0 / +8	40 x 47	

Refrigerated Counters 60cm DEPTH

BARLINE



1 2
ΧΩΡΙΣ ΜΗΧΑΝΗ

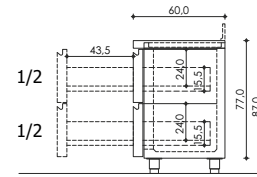

Double Drawers_ **€400**
Διπλή Συρταριέρα

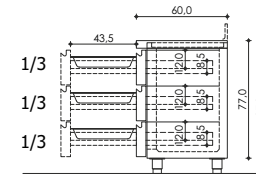

Triple Drawers_ **€600**
Τριπλή Συρταριέρα

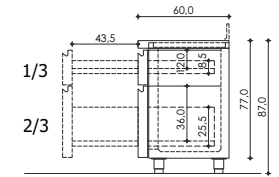

1/3-2/3 Drawers_ **€400**
1/3-2/3 Συρταριέρα

Soft close drawer runners_ **€50**
Συρταριέρες με μαλακό κλείσιμο



Evaporator with_ **€25**
protective coating



Sink Unit_ **€210**
Τοποθέτηση γούρνas



Splash Back_ **€100**
Πανωσίκωμα



Glass Door_ **€180**
Γυάλινη πόρτα

Line 60 Specifications



3 4

ΧΩΡΙΣ ΜΗΧΑΝΗ

5 6

REMOTE COMPRESSOR | ΧΩΡΙΣ ΜΗΧΑΝΗ

	Models R449a	Dimensions (l) x (w) x (h) cm	Vol. (lt)	
①	TR-096-2	113 x 60 x 87	220	2 DOORS
②	TR-106-2	126 x 60 x 87	250	
③	TR-146-3	160 x 60 x 87	310	3 DOORS
④	TR-166-3	179 x 60 x 87	370	
⑤	TR-186-4	207 x 60 x 87	420	4 DOORS
⑥	TR-216-4	233 x 60 x 87	510	

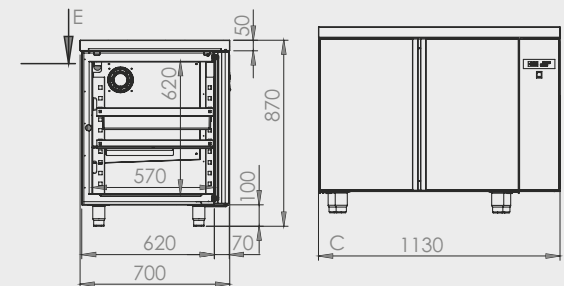

PLUG-IN @ sliding glass doors / Με μηχανή και συρόμενες γυάλινες διπλές πόρτες

	Models R449a	Dimensions (l) x (w) x (h) cm	Vol. (lt)	
	TR-146-S	141 x 60 x 87	220	2 DOORS
	TR-186-S	188 x 60 x 87	250	

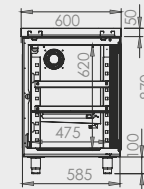

Line 70

GASTROLINE

Refrigerated Counters 70cm DEPTH



1 2 3 4

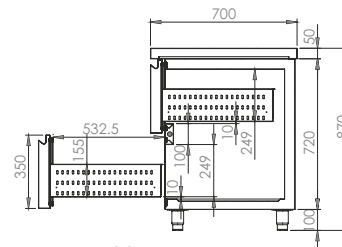

Double Drawers_ **€400**
Διπλή Συρταριέρα

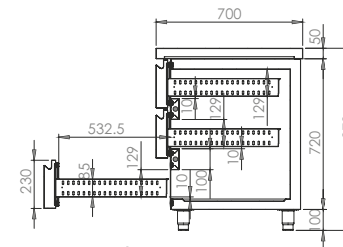

Triple Drawers_ **€600**
Τριπλή Συρταριέρα

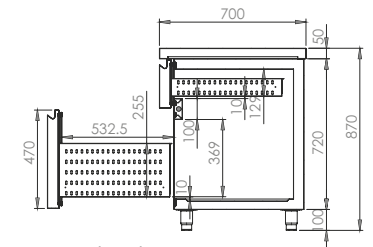

1/3-2/3 Drawers_ **€400**
1/3-2/3 Συρταριέρα

Soft close drawer runners_ **€50**
Συρταριέρες με μαλακό κλείσιμο

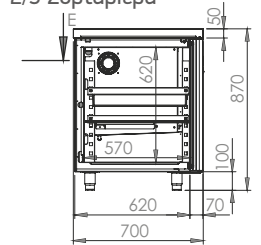

Evaporator with_ **€25**
protective coating



Sink Unit_ **€210**
Τοποθέτηση γούρνας



Splash Back_ **€100**
Πανωσίκωμα



Glass Door_ **€180**
Γυάλινη πόρτα

Line 70 Specifications



	Models R290	Models R449a	Dimensions (l) x (w) x (h) cm	Vol. (lt)	Power (W)/(hp)	Temp. (°C)	Grid (l) x (w) cm	
①	TR-147-GR	TR-147-G	141 x 70 x 87	260	435 /(1/4)	0 / +8	33.5 x 57	2 DOORS
②	TR-147-BR	TR-147-B	141 x 70 x 87	260	590 /(3/8)	-18 / -20	33.5 x 57	
③	TR-157-2R	TR-157-2	154 x 70 x 87	300	435 /(1/4)	0 / +8	40 x 57	2 DOORS
④	TR-157-BR	TR-157-B	154 x 70 x 87	300	772 /(1/2)	-18 / -20	40 x 57	
⑤	TR-187-GR	TR-187-G	188 x 70 x 87	380	590 /(3/8)	0 / +8	33.5 x 57	3 DOORS
⑥	TR-187-BR	TR-187-B	188 x 70 x 87	380	772 /(1/2)	-18 / -20	33.5 x 57	
⑦	TR-207-3R	TR-207-3	207 x 70 x 87	450	590 /(3/8)	0 / +8	40 x 57	3 DOORS
⑧	TR-207-BR	TR-207-B	207 x 70 x 87	450	772 /(1/2)	-18 / -20	40 x 57	
⑨	TR-237-GR	TR-237-G	235 x 70 x 87	510	772 /(1/2)	0 / +8	33.5 x 57	4 DOORS
⑩	TR-237-BR	TR-237-B	235 x 70 x 87	510	1043 /(3/4)	-18 / -20	33.5 x 57	
⑪	TR-267-4R	TR-267-4	261 x 70 x 87	600	772 /(1/2)	0 / +8	40 x 57	4 DOORS
⑫	TR-267-BR	TR-267-B	261 x 70 x 87	600	1043 /(3/4)	-18 / -20	40 x 57	
⑬	TR-287-GR	TR-287-G	282 x 70 x 87	680	772 /(3/4)	-0 / +8	40 x 57	5D.

Refrigeration ventilated

Freezer ventilated

5 DOORS

Refrigerated Counters 70cm DEPTH

GASTROLINE



1 2



3



4



1 2 3 4



5 6 7 8



9 10 11 12



13

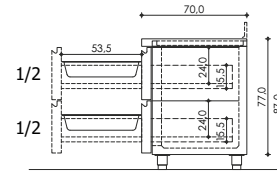

Double Drawers **€400**
Διπλή Συρταριέρα

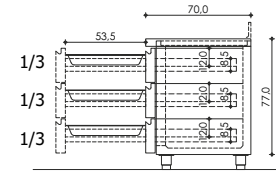

Triple Drawers **€600**
Τριπλή Συρταριέρα

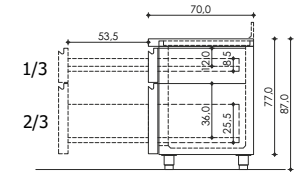

1/3-2/3 Drawers **€400**
1/3-2/3 Συρταριέρα

Soft close drawer runners **€50**
Συρταριέρες με μαλακό κλείσιμο



Splash Back **€100**
Πανωσέκωμα



Glass Door **€180**
Γυάλινη πόρτα

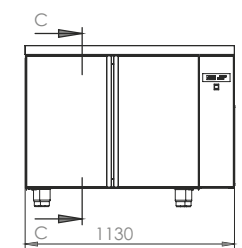
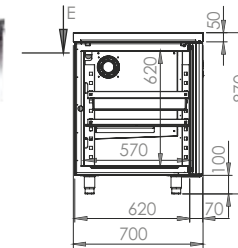

Line 70 Specifications

Optional Configuration

Drawer installation instead of Small door, upon Request

Προαιρετική επιλογή:

Τοποθέτηση συρταριού αντί μικρής πόρτας κατόπιν ζήτησης

Surcharge / Χρέωση € 200,00

COMPRESSOR ON THE RIGHT HAND SIDE | ΜΗΧΑΝΗ ΣΥΡΤΑΡΩΤΗ

	Models R290a	Models R449a	Dimensions (l) x (w) x (h) cm	Vol. (lt)	Doors No	Power (W)/(hp)	Temp. (°C)	Grid (l) x (w) cm	GN Dim.
①	TS-097-DR	TS-097-D	94 x 70 x 87	180	1 Large 1 Small	435 / (1/4)	0/+8	33.5 x 57	GN 1/1
②	TS-107-DR	TS-107-D	107 x 70 x 87	220	1 Large 1 Small	435 / (1/4)	0/+8	46 x 57	-
③	TS-147-DR	TS-147-D	141 x 70 x 87	280	2 Large 1 Small	435 / (1/4)	0/+8	33.5 x 57	GN 1/1
④	TS-187-DR	TS-187-D	188 x 70 x 87	400	3 Large 1 Small	772 / (1/2)	0/+8	33.5 x 57	GN 1/1

REMOTE COMPRESSOR | ΧΩΡΙΣ ΜΗΧΑΝΗ

	Models	Dimensions (l) x (w) x (h) cm	Vol. (lt)	
①	TR-097-2	113 x 70 x 87	220	2 DOORS
②	TB-097-2	113 x 70 x 87	220	
③	TR-107-2	126 x 70 x 87	250	
④	TB-107-2	126 x 70 x 87	250	

	Models	Dimensions (l) x (w) x (h) cm	Vol. (lt)	
⑤	TR-147-3	160 x 70 x 87	310	3 DOORS
⑥	TB-147-3	160 x 70 x 87	310	
⑦	TR-167-3	179 x 70 x 87	370	
⑧	TB-167-3	179 x 70 x 87	370	

	Models	Dimensions (l) x (w) x (h) cm	Vol. (lt)	
⑨	TR-187-4	207 x 70 x 87	420	4 DOORS
⑩	TB-187-4	207 x 70 x 87	420	
⑪	TR-217-4	233 x 70 x 87	510	
⑫	TB-217-4	233 x 70 x 87	510	
⑬	TR-237-5	254 x 70 x 87	600	5D.

5 DOORS



1



2

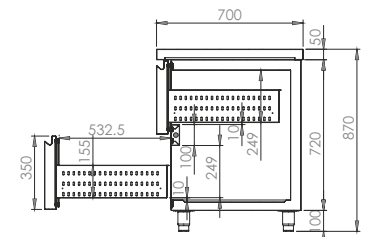

Double Drawers_ **€400**
Διπλή Συρταριέρα



3

Two evaporators
Δύο στοιχεία ψύξης



4

Two evaporators
Δύο στοιχεία ψύξης

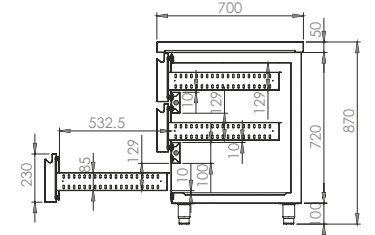

Triple Drawers_ **€600**
Τριπλή Συρταριέρα



5

Two evaporators
Δύο στοιχεία ψύξης



6

Two evaporators
Δύο στοιχεία ψύξης

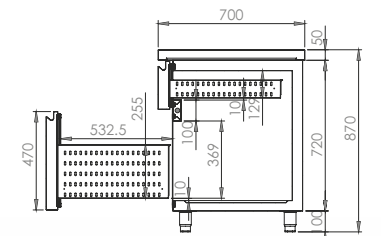

1/3-2/3 Drawers_ **€400**
1/3-2/3 Συρταριέρα

Soft close drawer runners_ **€50**
Συρταριέρες με μαλακό κλείσιμο

Line 70 Specifications

	Models R290	Models R449a	Dimensions (l) x (w) x (h) cm	Drawers	Power (W)/(hp)	Temp. (°C)	Grid (l) x (w) cm
①	TR-147-G4R	TR-147-G4	141 x 70 x 87	4	435 /(1/4)	0 / +8	33.5 x 57
②	TR-147-B4R	TR-147-B4	141 x 70 x 87	3	590 /(3/8)	-18 / -20	33.5 x 57
③	TR-187-G6R	TR-187-G6	188 x 70 x 87	6	435 /(1/4)	0 / +8	33.5 x 57
④	TR-187-B6R	TR-187-B6	188 x 70 x 87	3	772 /(1/2)	-18 / -20	33.5 x 57
⑤	TR-237-G8R	TR-237-G8	235 x 70 x 87	8	435 /(1/4)	0 / +8	33.5 x 57
⑥	TR-237-B8R	TR-237-B8	235 x 70 x 87	3	772 /(1/2)	-18 / -20	33.5 x 57

Refrigerated Counters 70cm DEPTH

GASTROLINE



1

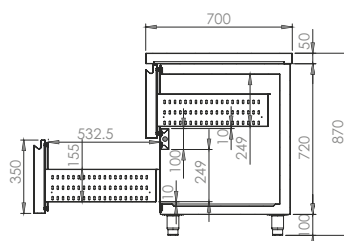

Double Drawers_ €400
Διπλή Συρταριέρα



2



3

Two evaporators
Δύο στοιχεία ψύξης



new

4



5



6

Line 70 Specifications

Soft close drawer runners_ €50
Συρταριέρες με μαλακό κλείσιμο

	Models R290	Models R449a	Dimensions (l) x (w) x (h) cm	Drawers	Power (W)/(hp)	Temp. (°C)	Grid (l) x (w) cm
①	TS-097-3R	TS-097-3	94 x 70 x 87	3	435 /(1/4)	0 / +8	Gn 1/1
②	TS-147-5R	TS-147-5	141 x 70 x 87	5	590 /(3/8)	0 / +8	Gn 1/1
③	TS-187-7R	TS-187-7	188 x 70 x 87	7	772 /(1/2)	0 / +8	Gn 1/1
④	TR-152-2R	TR-152-2	154 x 70 x 87	2	590 /(3/8)	0 / +8	-
⑤	T2-187-GR	T2-187-G	188 x 70 x 87	2/1 doors	772 /(1/2)	0/+8 @ -16/-20	Gn 1/1
⑥	T2-237-GR	T2-237-G	235 x 70 x 87	2/2 doors	850 /(3/4)	0/+8 @ -16/-20	Gn 1/1



1

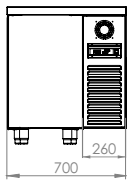

2

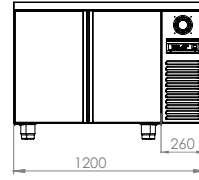

3

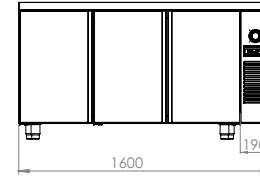

4

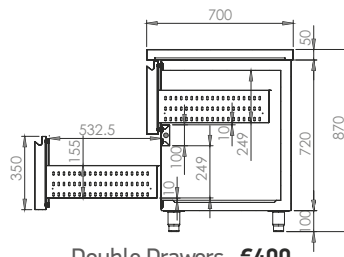
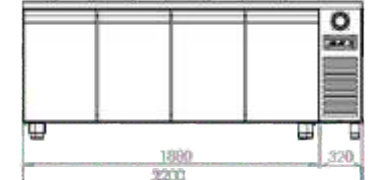

Soft close drawer runners_ **€50**
Συρταριέρες με μαλακό κλείσιμο

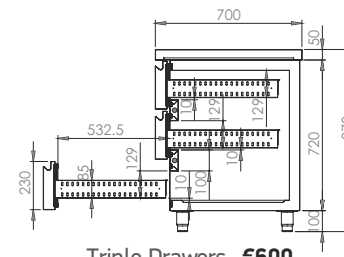

Double Drawers_ **€400**
Διπλή Συρταριέρα

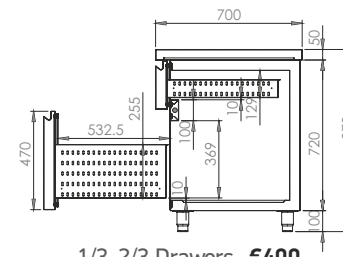

Triple Drawers_ **€600**
Τριπλή Συρταριέρα

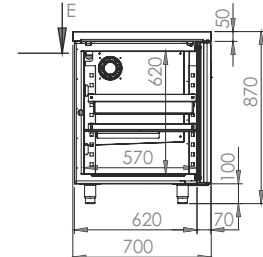

1/3-2/3 Drawers_ **€400**
1/3-2/3 Συρταριέρα

Line 70 short Specifications



COMPRESSOR ON THE RIGHT HAND SIDE | ΜΗΧΑΝΗ ΔΕΞΙΑ

	Models R290	Models R449a	Dimensions (l) x (w) x (h) cm	Vol. (lt)	Power (W)/(hp)	Temp. (°C)	Grid (l) x (w) cm
①	TR-077-GR	TR-077-G	70 x 70 x 87	130	435 /(1/4)	0/+8	G/N 1/1
②	TR-127-GR	TR-127-G	120 x 70 x 87	260	435 /(1/4)	0/+8	G/N 1/1
③	TR-167-GR	TR-167-G	160 x 70 x 87	380	590 /(3/8)	0/+8	G/N 1/1
④	TR-217-GR	TR-217-G	220 x 70 x 87	510	772 /(1/2)	0/+8	G/N 1/1



Evaporator with_ **€25**
protective coating



Splash Back_ **€100**
Πανωσήκωμα



Glass Door_ **€200**
Γυάλινη πόρτα

Refrigerated Counters 70cm DEPTH

SALAD LINE



1



2

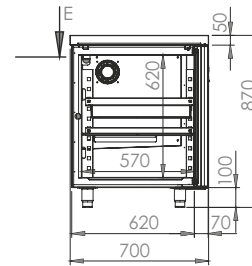

Table Refrigerator with 2 Drawers
Επιτραπέζιο ψυγείο με 2 συρτάρια



4

Cooling Counter with Large Drawers
Ψυχόμενος Πάγκος με Φαρδιά Συρτάρια



3

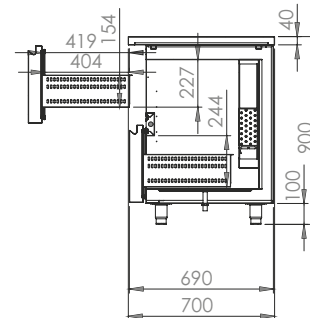
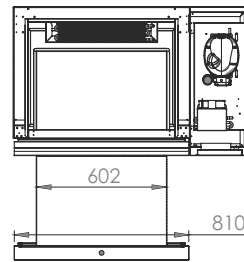

Soft close drawer runners_€50
Συρταριές με μαλακό κλείσιμο

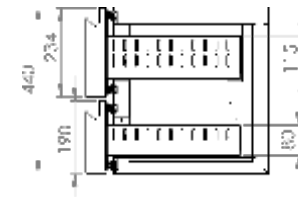

Soft close drawer runners_€50
Συρταριές με μαλακό κλείσιμο

Salad Line Specifications

Optional Configuration

Drawer installation instead of Small door, upon Request

Προεραϊκή επιλογή:

Τοποθέτηση συρταριού αντί μικρής πόρτας κατόπιν ζήτησης

Surcharge / Χρέωση € 200,00



Evaporator with_€25 protective coating

	Models R290	Models R449a	Dimensions (l) x (w) x (h) cm	Vol. (lt)	Power (W)/(hp)	Temp. (°C)	Grid (l) x (w) cm	Scoops
①	TR-107-SR	TR-107-S	107 x 70 x 87	210	435 / (1/4)	0/+8	40 x 57	12x1/4 GN
②	TR-147-SR	TR-147-S	141 x 70 x 87	280	590 / (3/8)	0/+8	33,5x57 - GN 1/1	16x1/4 GN
	Models R290	Models R449a	Dimensions (l) x (w) x (h) cm	Power (W)/(hp)	Capacity	Temp. (°C)	Weight (Kg.)	
③	TR-117-DR2R	TR-117-DR2	110 x 70 x 90	435 (1/4)	60 x 40	0/+8	70	
	TB-117-DR2R	TB-117-DR2	110 x 70 x 90	590 (3/8)	60 x 40	-20 / -25	80	
	Models R290	Models R449a	Dimensions (l) x (w) x (h) cm	Power (W)/(hp)	Capacity	Temp. (°C)	Weight (Kg.)	
④	MO-104-2R	MO-104-2	108 x 48 x 44	435 / (1/4)	2 G/N	0/+8	60	

MODULO 40cm



1

MODULO 40cm



2

MODULO 40cm



3



MODULO 40cm

	Models R290	Models R449a	Dimensions (l) x (w) x (h) cm	Vol. (lt)	Drawers No	Power (W)/(hp)	Temp. (°C)	Grid (l) x (w) cm
①	TR-127-LR	TR-127-L	120 x 70 x 68	160	4	435 / (1/4)	0 / +8	1/1
②	TR-167-LR	TR-167-L	160 x 70 x 68	190	6	590 / (3/8)	0 / +8	1/1
③	TR-207-LR	TR-207-L	200 x 70 x 68	240	6	590 / (3/8)	0 / +8	1/1



1



2



3

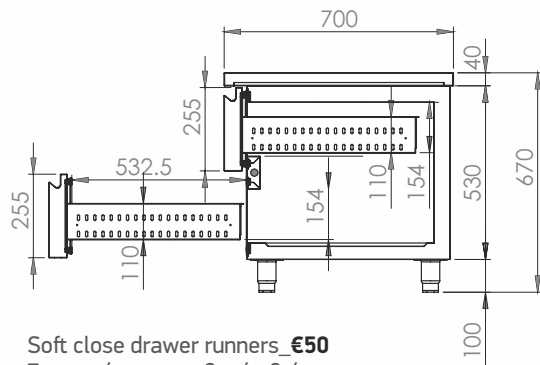

	Models R290	Models R449a	Dimensions (l) x (w) x (h) cm	Vol. (lt)	Drawers No	Power (W)/(hp)	Temp. (°C)	Grid (l) x (w) cm
①	TR-147-LR	TR-147-L	141 x 70 x 68	160	4	435 / (1/4)	0 / +8	1/1
②	TR-187-LR	TR-187-L	188 x 70 x 68	190	6	590 / (3/8)	0 / +8	1/1
③	TR-237-LR	TR-237-L	235 x 70 x 68	240	8	772 / (1/2)	0 / +8	1/1

Soft close drawer runners_€50
Συρταριέρες με μαλακό κλείσιμο



1 2



3



4

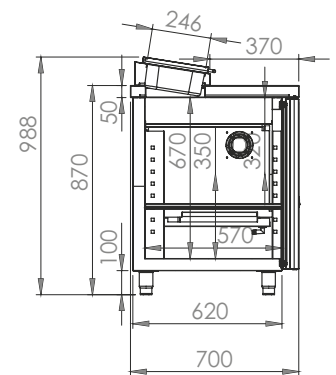
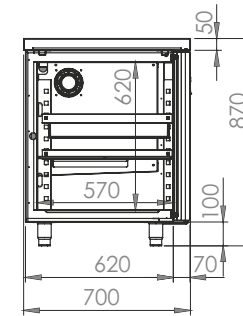

5



6



7

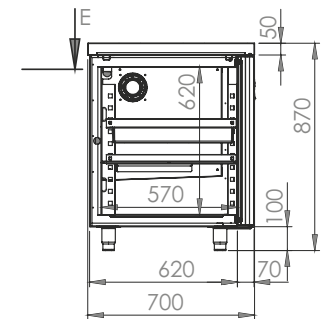

Specifications

CHARACTERISTICS / ΧΑΡΑΚΤΗΡΙΣΤΙΚΑ

- Stainless steel interior & exterior construction
- Polyurethane Ecological insulation
- Health Cooler Pad
- Grids laminated, height adjustable
- Inox Guides for GN basins
- Hinged Doors with automatic reset system
- Limit switch for fan shutdown upon door opening
- Magnetic gaskets [removable]
- Ecological Refrigerant R449a or R290
- Electronic thermostat - thermometer for temperature control
- Automatic defrosting
- Sewerage system including water evaporator
- Cooling Convection
- Static Cooling System

	Models R290	Models R449a	Dimensions (l) x (w) x (h) cm	Vol. (lt)	Power (W)/(hp)	Temp. (°C)	Grid (l) x (w) cm
①	TR-097-TR	TR-097-T	94 x 70 x 99	220	435 / (1/4)	0 / +8	33.5 x 57
②	TR-107-TR	TR-107-T	107 x 70 x 99	250	435 / (1/4)	0 / +8	40 x 57
③	TR-147-TR	TR-147-T	141 x 70 x 99	310	435 / (1/4)	0 / +8	33.5 x 57
④	TR-187-TR	TR-187-T	187 x 70 x 99	370	590 / (3/8)	0 / +8	33.5 x 57
	Models R290	Models R449a	Dimensions (l) x (w) x (h) cm	Vol. (lt)	Power (W)/(hp)	Temp. (°C)	Grid (l) x (w) cm
⑤	TR-14G-GR	TR-14G-G	141 x 70 x 86	260	435 / (1/4)	0 / +8	33.5 x 57
⑥	TR-18G-GR	TR-18G-G	188 x 70 x 86	380	590 / (3/8)	0 / +8	33.5 x 57
⑦	TR-23G-GR	TR-23G-G	235 x 70 x 86	510	590 / (3/8)	0 / +8	33.5 x 57

Line 80

BAKERLINE 40 x 60

Refrigerated Counters 80cm DEPTH



1

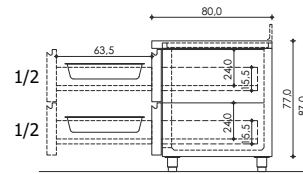
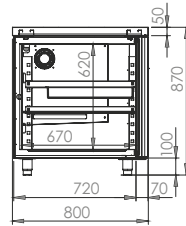

Double Drawers_ **€400**
Διπλή Συρταριέρα

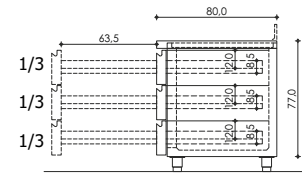

Triple Drawers_ **€600**
Τριπλή Συρταριέρα

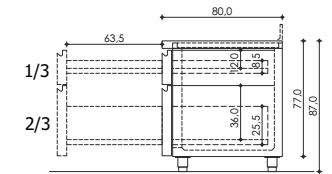

1/3-2/3 Drawers_ **€400**
1/3-2/3 Συρταριέρα



4

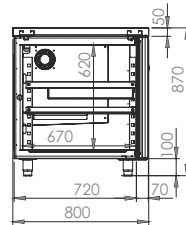

Evaporator with_ **€25**
protective coating



Sink Unit_ **€210**
Τοποθέτηση γούρνας



Splash Back_ **€100**
Πανωσίκωμα



Glass Door_ **€180**
Γυάλινη πόρτα

Line 80 Specifications

COMPRESSOR ON THE RIGHT HAND SIDE | ΜΗΧΑΝΗ ΔΕΞΙΑ



2

3

	Models R290	Models R449a	Dimensions (l) x (w) x (h) cm	Vol. (lt)	Power (W)/(hp)	Temp. (°C)	Grid (l) x (w) cm
①	TR-158-2R	TR-158-2	154 x 80 x 87	410	590 / (3/8)	0/+8	40 x 60
②	TR-208-3R	TR-208-3	208 x 80 x 87	620	772 / (1/2)	0/+8	40 x 60
③	TR-268-4R	TR-268-4	261 x 80 x 87	700	850 / (3/4)	0/+8	40 x 60

REMOTE COMPRESSOR | ΧΩΡΙΣ ΜΗΧΑΝΗ



5

6

	Models R290	Models R449a	Dimensions (l) x (w) x (h) cm	Vol. (lt)	Power (W)/(hp)	Temp. (°C)	Grid (l) x (w) cm
④	TR-108-2R	TR-108-2	126 x 80 x 87	410	590 / (3/8)	0/+8	40 x 60
⑤	TR-168-3R	TR-168-3	179 x 80 x 87	620	772 / (1/2)	0/+8	40 x 60
⑥	TR-218-4R	TR-218-4	233 x 80 x 87	700	850 / (3/4)	0/+8	40 x 60

Πάγκοι πίτσας με επιτραπέζιο βιτρινάκι

PIZZALINE



1



2



3



4

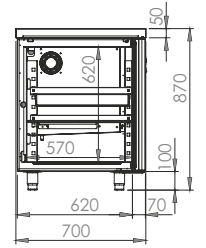

5



6



7

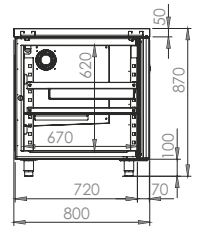

Soft close drawer runners_€50
Συρταριέρες με μαλακό κλείσιμο

Pizza counters Specifications

Optional black granite top_€200
Επιλογή γρανίτη μαύρου χρώματος_€200

CHARACTERISTICS / ΧΑΡΑΚΗΡΙΣΤΙΚΑ

Advantages

- High performance and low energy consumption thanks to high density polyurethane insulation thickness and R290 refrigerant gas
- High quality product and finish
- Easy internal cleaning thanks to the rounded corner and removable shelves without the need for special tools, the drawers are neutral
- Mounted on adjustable feet. Wheels can be provided on request, we propose different models of complete pizza counters, designed to give flexible and qualitatively superior solutions
- Available with depths 70 and 80 cm, with a neutral set of drawers with different combination possibilities for 1/1 and in 40x60

Πλεονεκτήματα

- Υψηλή απόδοση και χαμηλή κατανάλωση ενέργειας χάρη στο πάχος της μόνωσης πολυουρεθάνης, της υψηλής πυκνότητας και στο ψυκτικό αέριο R290
- Προϊόν υψηλής ποιότητας και φινιρίσμα
- Εύκολος εσωτερικός καθαρισμός χάρη τις

	Models R290	Models R449a	Dimensions (l) x (w) x (h) cm	Vol. (lt)	Power (W)/(hp)	Temp. (°C)	G/N - Pans Dimensions
①	TR-127-PR	TR-127-P	120 x 70 x 145	210	590 / (3/8)	0/+8	1/4
②	TR-147-PR	TR-147-P	141 x 70 x 145	280	590 / (3/8)	0/+8	1/4
③	TR-107-PR	TR-107-P	107 x 70 x 122	230	590 / (3/8)	0/+8	1/4
④	TR-147-PR	TR-147-P	141 x 70 x 122	300	590 / (3/8)	0/+8	1/4
③	TR-108-PR	TR-108-P	107 x 80 x 122	230	590 / (3/8)	0/+8	1/4
④	TR-148-PR	TR-148-P	141 x 80 x 122	300	590 / (3/8)	0/+8	1/4
⑤	TR-158-PR	TR-158-P	154 x 80 x 145	410	575 / (3/8+1/4)	0/+8	1/3 - 60/40
⑥	TR-208-PR	TR-208-P	207 x 80 x 145	620	770 / (1/2+1/4)	0/+8	1/3 - 60/40
⑦	TR-20S-PR	TR-20S-P	207 x 80 x 145	410	585 / (3/8+1/4)	0/+8	1/3 - 60/40

στρογγυλεμένες γωνίες και τις αφαιρούμενες σχάρες χωρίς την ανάγκη ειδικών εργαλείων, τα συρτάρια είναι ουδέτερα

- Τοποθετείται σε ρυθμιζόμενα πόδια. Ρόδες μπορούν να παρέχονται κατόπιν αιτήματος, προτείνουμε διαφορετικά μοντέλα πλήρων πάγκων πίτσας, σχεδιασμένα να δίνουν

ευέλικτες και ποιοτικά ανώτερες λύσεις

- Διατίθεται με βάση 70 και 80 εκ, με ουδέτερο σετ συρταριών με διαφορετικές δυνατότητες συνδυασμών για 1/1 και 40x60

Bottle cooler height 100

BARLINE

Refrigerated Counters 100cm height



1



2



3

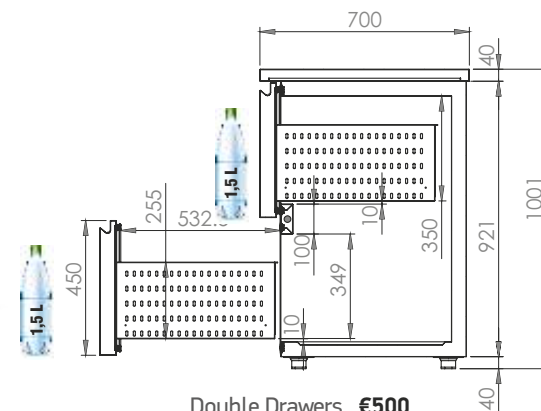

Double Drawers_ **€500**
Διπλή Συρταριέρα

Soft close drawer runners_ **€50**
Συρταριέρες με μαλακό κλείσιμο



Total price_ **€3.650**



Total price_ **€4.150**



Total price_ **€4.650**



Optional drainer top and sink 40x40x25_ **€700**
Σκαφωτό καπάκι, γούρνα 40x40x25και αποχέτευση



Glass Door_ **€200**
Γυάλινη πόρτα

Line 70 tall Specifications

CHARACTERISTICS / ΧΑΡΑΚΤΗΡΙΣΤΙΚΑ

This is the new series of counter fridges especially for bar shops that need many liters of refrigerated space and great ergonomics. In the same dimension, they give 50% more useful space than classic refrigerators and it has been studied to fit all the bottles that can be used by a restaurant. It is made with a double or triple of drawers unit or with a glass door and with an Inox door as well as with top with sink.

Πρόκειται για τη νέα σειρά πάγκων ψυγείων ειδικά για καταστήματα μπαρ που έχουν ανάγκη πολλών λίτρων ψυχόμενου χώρου και μεγάλης εργονομίας. Στην ίδια διάσταση δίνουν 50% περισσότερο ωφέλιμο χώρο από τα κλασικά ψυγεία και έχει μελετηθεί να χωράνε όλα τα μπουκάλια που μπορεί να χρησιμοποιήσει ένα κατάστημα εστίασης. Κατασκευάζεται με διπλή ή τριπλή συρταριέρα, με γυάλινη πόρτα και με inox πόρτα όπως και με σκαφωτό καπάκι με γούρνα.

	Models R290	Models R449a	Dimensions (l) x (w) x (h) cm	Vol. (lt)	Power (W)/(hp)	Temp. (°C)	Grid (l) x (w) cm
①	TR-147-2HR	TR-147-2H	155 x 70 x 100	380	590 /(3/8)	0/+8	33,5 x 57
②	TR-157-2HR	TR-157-2H	210 x 70 x 100	550	772 /(1/2)	0/+8	33,5 x 57
③	TR-187-3HR	TR-187-3H	265x 70 x 100	730	850 /(3/4)	0/+8	33,5 x 57

inox or glass door
inox ή κρυστάλλινη πόρτα

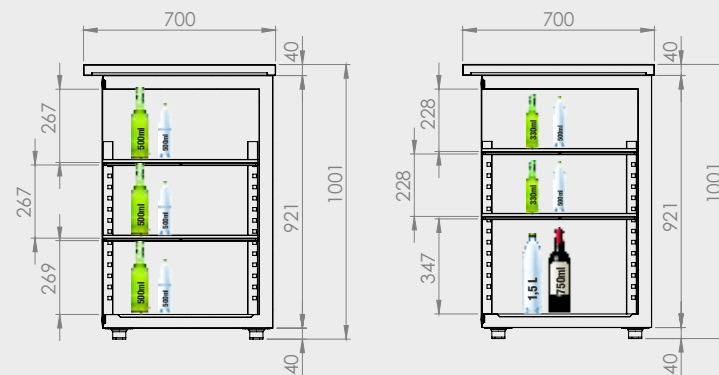

Bottle cooler height 90

Refrigerated Counters 90cm height

BARLINE



1



2



3



Total price **€3.350**



Total price **€3.850**



Total price **€4.350**

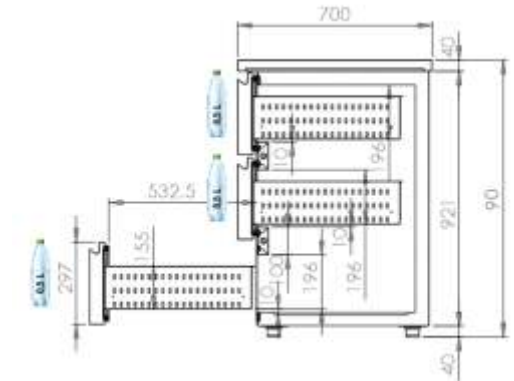

Triple Drawers **€750**

Τριπλή Συρταριέρα

Soft close drawer runners **€50**

Συρταριέρες με μαλακό κλείσιμο



Optional drainer top and sink 40x40x25 **€700**

Σκαφωτό καπάκι, γούρνα 40x40x25 και αποχέτευση



Glass Door **€200**
Γυάλινη πόρτα

Line 70 tall Specifications

CHARACTERISTICS / ΧΑΡΑΚΤΗΡΙΣΤΙΚΑ

This is the new series of counter fridges especially for bar shops that need many liters of refrigerated space and great ergonomics. In the same dimension, they give 50% more useful space than classic refrigerators and it has been studied to fit all the bottles that can be used by a restaurant. It is made with a double or triple of drawers unit or with a glass door and with an Inox door as well as with top with sink.

Πρόκειται για τη νέα σειρά πάγκων ψυγείων ειδικά για καταστήματα μπαρ που έχουν ανάγκη πολλών λίτρων ψυχόμενου χώρου και μεγάλης εργονομίας. Στην ίδια διάσταση δίνουν 50% περισσότερο ωφέλιμο χώρο από τα κλασικά ψυγεία και έχει μελετηθεί να χωράνε όλα τα μπουκάλια που μπορεί να χρησιμοποιήσει ένα κατάστημα εστίασης. Κατασκευάζεται με διπλή ή τριπλή συρταριέρα, με γυάλινη πόρτα και με inox πόρτα όπως και με σκαφωτό καπάκι με γούρνα.

	Models R290	Models R449a	Dimensions (l) x (w) x (h) cm	Vol. (lt)	Power (W)/(hp)	Temp. (°C)	Grid (l) x (w) cm
①	TR-14H-2HR	TR-14H-2H	155 x 70 x 90	360	590 / (3/8)	0/+8	33,5 x 57
②	TR-15H-2HR	TR-15H-2H	210 x 70 x 90	520	772 / (1/2)	0/+8	33,5 x 57
③	TR-18H-3HR	TR-18H-3H	265 x 70 x 90	700	850 / (3/4)	0/+8	33,5 x 57

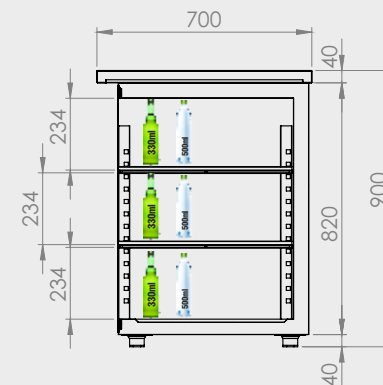

Evaporator with **€25** protective coating